

# AHLxxx Low-Voltage Nanopower Digital Switches

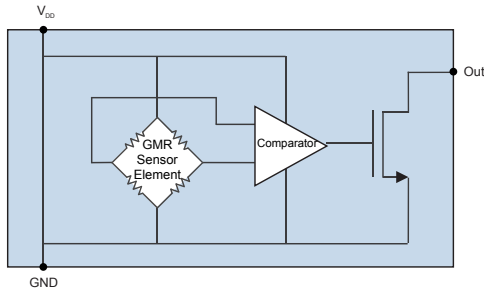

## Functional Diagrams



**AHL9xx**  
(continuous duty)

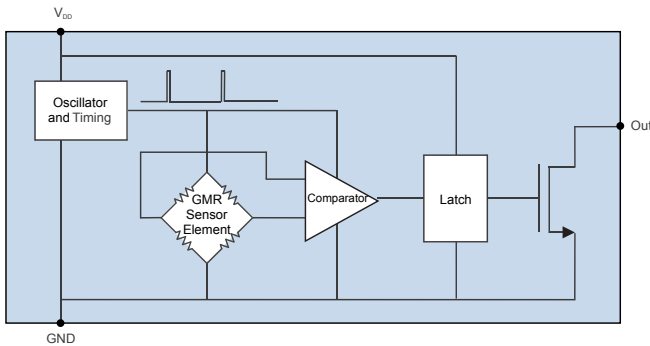

**AHL0xx**  
(duty-cycled)

## Features

- 0.9 V – 2.4 V operating voltage
- Power as low as less than 1 microwatt
- Sensitive operate points, as low as 5 Oe
- Precise detection of low magnetic fields
- Ultraminiature 1.1 x 1.1 mm package

## Applications

- Gas and water meters
- Portable instruments
- Single-cell battery or harvested power applications

## Description

The AHLxxx-14E series sensors are Giant Magnetoresistive (GMR) Digital Switch devices designed to run at low voltages and extremely low currents. The devices are manufactured with NVE’s patented spintronic GMR technology for unmatched miniaturization, sensitivity, precision, and low power.

The output is configured as a magnetic “switch” where the output turns on when the magnetic field is applied, and turns off when the field is removed. Versions are available that are either continuous duty or internally duty cycled operation to further reduce power consumption. An integrated latch ensures the output is available continuously in duty-cycled versions.

The applied field can be of either polarity, and the operate point is extremely stable over supply voltage and temperature. The output is current-sinking, and can sink up to 100 microamps.

The product consists of an approximately 0.6 mm x 0.6 mm die containing a GMR sensor element, CMOS signal processing circuitry to convert the analog sensor element output to a digital output, and an oscillator and timing circuit for duty cycling.

The parts use NVE’s ultraminiature 1.1 mm x 1.1 mm ULLGA leadless packages. Bare die are also available.

A range of magnetic operate points are available, and custom thresholds can be provided.

## Idealized Magnetic Response

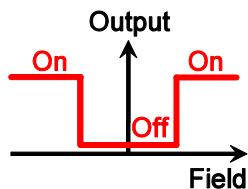

**Absolute Maximum Ratings**

Parameter	Min.	Max.	Units
Supply voltage		5.5	Volts
Output voltage		5.5	Volts
Output current		200	μA
Storage temperature	-65	170	°C
Junction temperature		170	°C
Applied magnetic field		Unlimited	

**Operating Specifications**

T <sub>min</sub> to T <sub>max</sub> ; 0.9 V < V <sub>DD</sub> < 2.4 V unless otherwise stated.						
Parameter	Symbol	Min.	Typ.	Max.	Units	Test Condition
Supply voltage (note 1)	V <sub>DD</sub>	0.9		2.4	Volts	
Operating temperature	T <sub>MIN</sub> ; T <sub>MAX</sub>	-40		85	°C	
Magnetic operate point	H <sub>OP</sub>					
AHLx25		7	10	14		
AHLx21		15	20	25		
AHLx24		21	28	34		
AHLx23		50	60	70		
Magnetic release point	H <sub>REL</sub>	2			Oe	
Hysteresis		0.5			Oe	
Quiescent current	I <sub>DDQ</sub>		0.032	0.06	μA	V <sub>DD</sub> = 0.9V
AHL0xx			15	35		
AHL9xx			0.095	0.15		
AHL0xx			35	55		
AHL9xx			0.46	0.65		
AHL9xx			75	110		
AHL0xx peak supply current	I <sub>DD-PK</sub>		25	55	μA	V <sub>DD</sub> = 1.4V
Output drive current	I <sub>OL-ON</sub>	100			μA	
Output low voltage	V <sub>OL</sub>		0.05	0.2	V	V <sub>DD</sub> = 1.25V; I <sub>OL-ON</sub> = 100 μA
Output leakage current	I <sub>OL-OFF</sub>		0.095	0.5	μA	
Frequency response					Hz	V <sub>DD</sub> = 0.9V
		30	40	60		
		80	110	160		
AHL0xx		120	260	375		
AHL9xx			100k			

**Notes:**

1. Operation from -20°C to -40°C at supply voltages less than 1 V may not meet specifications.
2. Soldering profile per JEDEC J-STD-020C, MSL 1.

**Operation**

**Direction of Magnetic Sensitivity**

As the field varies in intensity, the digital output will turn on and off. Unlike Hall effect or other sensors, the direction of sensitivity is in the plane of the package. The diagrams below show two permanent magnet orientations that will activate the sensor in the direction of sensitivity:

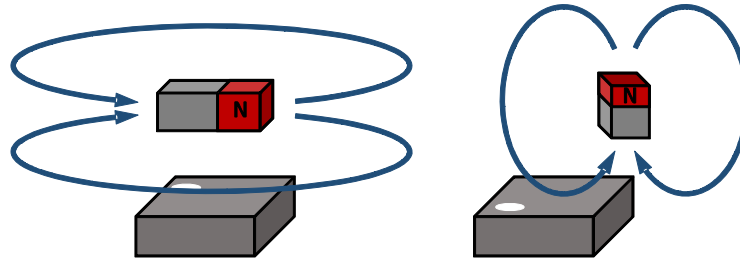

**Figure 1. AHL-Series sensor direction of magnetic sensitivity.**

AHL-Series Sensors are “omnipolar,” meaning the outputs turn ON when a magnetic field of either magnetic polarity is applied.

**External Pull-Up Resistor**

The output is a logic low when the sensor is activated. The output is open-drain should have an external pull-up resistor. For microcontroller interfaces, the microcontroller’s input pull-up resistors can be activated.

**Typical Operation**

Figure 2 shows typical AHL-Series sensor orientation. The arrow on the circuit board shows the direction of magnetic sensitivity:

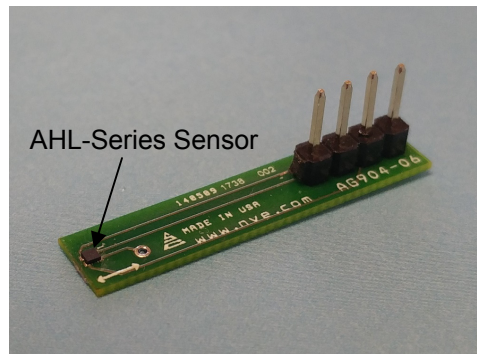

**Figure 2. Typical operation; the circuit board arrow shows direction of sensitivity.**

Typical magnetic operate and release distances for an inexpensive 4 mm diameter by 6 mm thick ceramic disk magnet, are illustrated in the following table:

Part	Operate Point (typ.)	Operate Distance (typ.)	Release Distance (typ.)
AHLx25-14E	10 Oe	14 mm	18 mm
AHLx21-14E	20 Oe	10 mm	12 mm
AHLx24-14E	28 Oe	9 mm	11 mm
AHLx23-14E	60 Oe	7 mm	8 mm

Larger and stronger magnets allow farther operate and release distances. For more calculations, use our digital sensor switching versus distance Web application at: [www.nve.com/spec/calculators.php](http://www.nve.com/spec/calculators.php).

**Typical Performance**

Supply Current vs. Supply Voltage, 25°C, AHL9xx

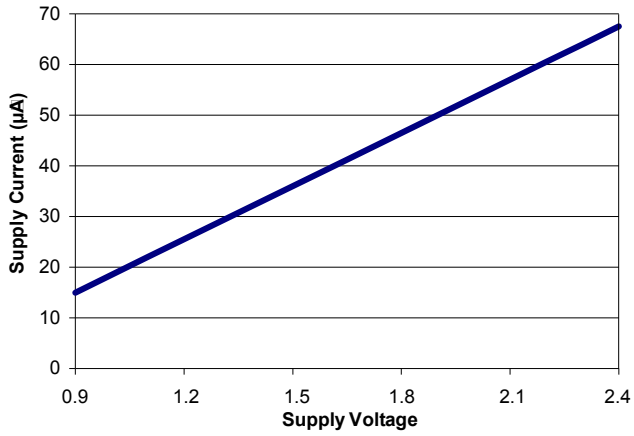

Magnetic Operate Point vs. Supply Voltage  
25°C, AHLxxx

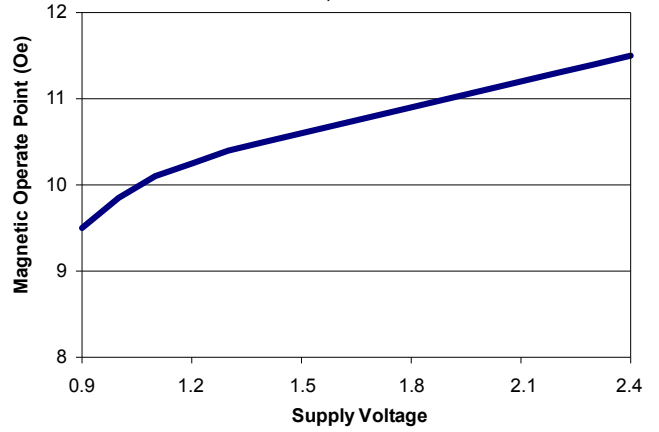

Average Supply Current vs. Supply Voltage, 25°C  
AHL0xx

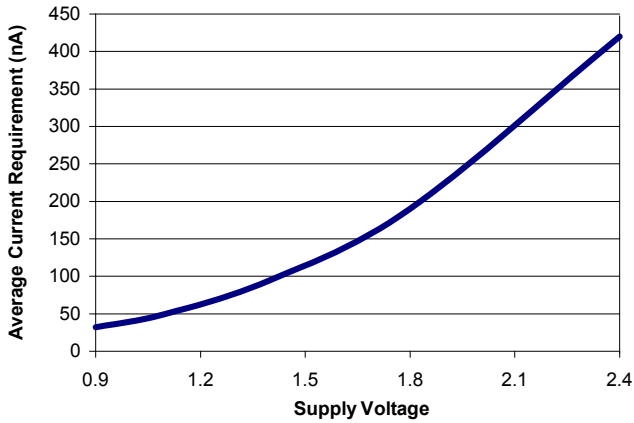

Magnetic Operate Point vs. Temperature,  
1.15V, AHLxxx

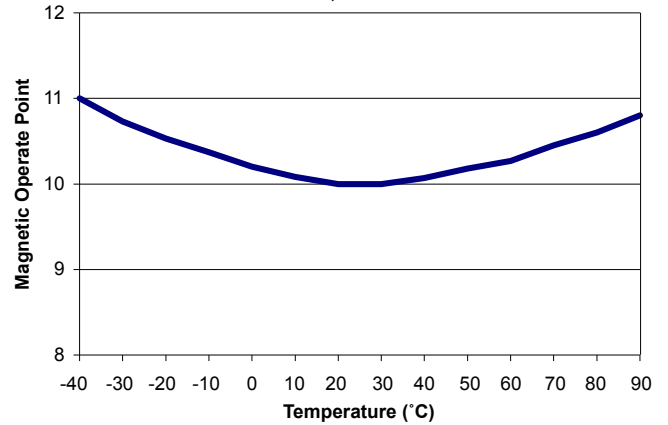

Frequency Response vs. Supply Voltage, 25°C, AHL0xx

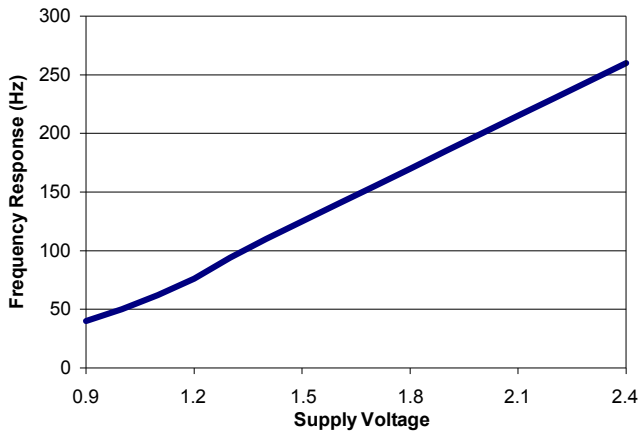

Supply Voltage vs. Temperature Derating Curve

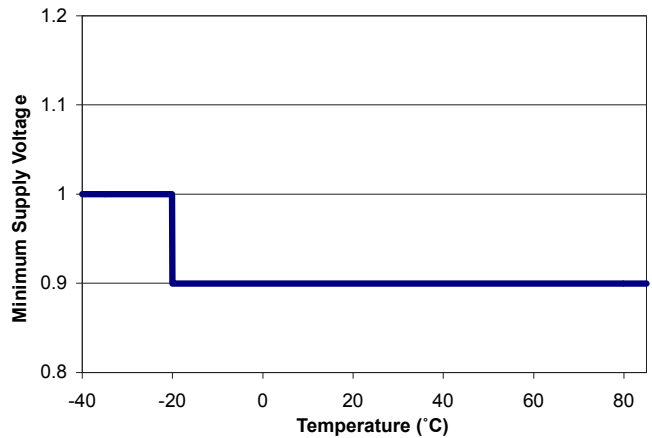

## Part Numbering

The following example shows the AHL-Series part-numbering system:

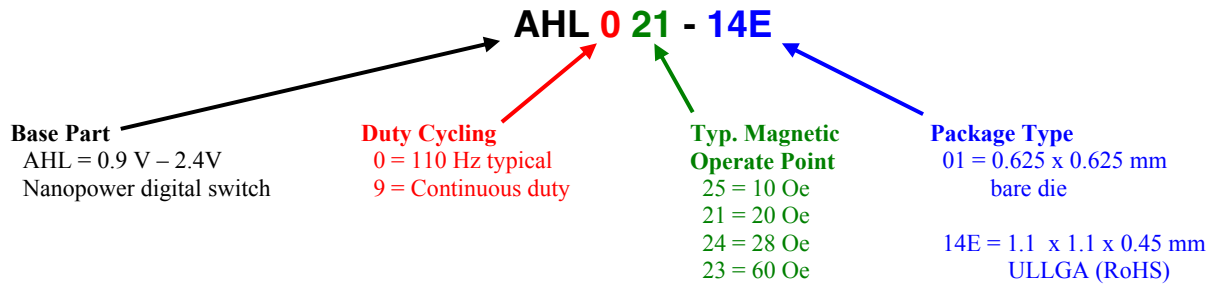

## Available Parts

Available Part	Duty Cycled?	Update Freq. (typ.)	Operate Point (typ.)	Package	Package Marking
AHL021-01	Y	110 Hz	20 Oe	die	
AHL021-14E	Y	110 Hz	20 Oe	ULLGA	b
AHL023-01	Y	110 Hz	60 Oe	die	
AHL023-14E	Y	110 Hz	60 Oe	ULLGA	r
AHL024-01	Y	110 Hz	28 Oe	die	
AHL024-14E	Y	110 Hz	28 Oe	ULLGA	d
AHL025-01	Y	110 Hz	10 Oe	die	
AHL025-14E	Y	110 Hz	10 Oe	ULLGA	e
AHL921-01	N	Continuous	20 Oe	die	
AHL921-14E	N	Continuous	20 Oe	ULLGA	f
AHL924-01	N	Continuous	28 Oe	die	
AHL924-14E	N	Continuous	28 Oe	ULLGA	h
AHL925-01	N	Continuous	10 Oe	die	
AHL925-14E	N	Continuous	10 Oe	ULLGA	Xj / j

## Bare Circuit Boards

NVE offers two bare circuit boards designed for easy connections to ULLGA sensors. Note that since these boards use very small sensors, they require reflow or hot-air soldering techniques. Images are actual size:



### AG904-06: ULLGA General-Purpose PCB

1.2 x 0.25 inch (30 x 6 mm) PCB for demonstrating 1.1 x 1.1 mm ULLGA4 sensors (-14E sensor suffix).



### AG039-06: ULLGA Digital Sensor Demonstration Bare Board

A 1.57 x 0.25 inch PCB for demonstrating AHL-Series sensors (sensors sold separately). In addition to space for the sensor, the boards have locations for 0402-size pull-up resistors and bypass capacitors.

**1.1 mm x 1.1 mm ULLGA Package (-14E suffix)**

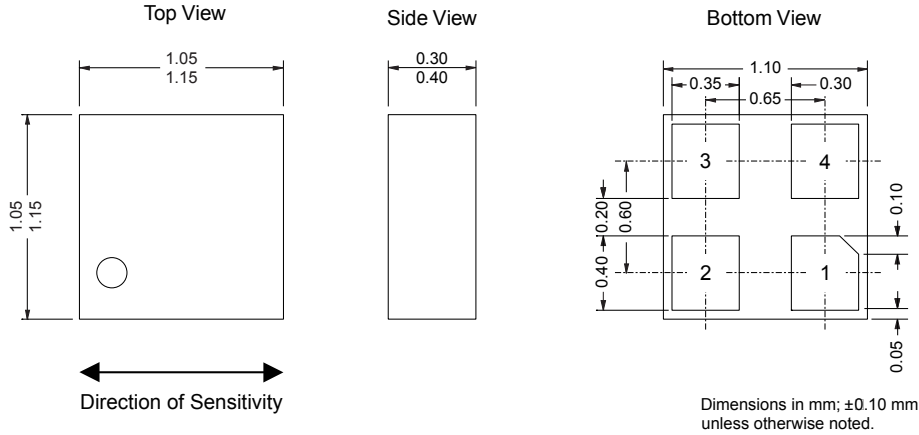

Pin 1	No Connect
Pin 2	V <sub>DD</sub>
Pin 3	Out
Pin 4	Ground

Soldering profiles per JEDEC J-STD-020C, MSL 1.

*These products have been tested for electrostatic sensitivity to the limits stated in the specifications. However, NVE recommends that all integrated circuits be handled with appropriate care to avoid damage. Damage caused by inappropriate handling or storage could range from performance degradation to complete failure.*



**Revision History**

---

**SB-00-027**

November 2017

**Change**

- Added “Typical Operation” section and image (p. 3).
- Added bare boards (p. 5).

**SB-00-027**

October 2017

**Change**

- Revised package outline dimensions.

**SB-00-027**

July 2017

**Change**

- Deleted AHL927 (replaced with AFL006).

**SB-00-027**

April 2017

**Changes**

- Added AHL927 part type.
- Added package marking codes.
- Specified minimum ULLGA package thickness.
- Cosmetic changes.

### Datasheet Limitations

The information and data provided in datasheets shall define the specification of the product as agreed between NVE and its customer, unless NVE and customer have explicitly agreed otherwise in writing. All specifications are based on NVE test protocols. In no event however, shall an agreement be valid in which the NVE product is deemed to offer functions and qualities beyond those described in the datasheet.

### Limited Warranty and Liability

Information in this document is believed to be accurate and reliable. However, NVE does not give any representations or warranties, expressed or implied, as to the accuracy or completeness of such information and shall have no liability for the consequences of use of such information.

In no event shall NVE be liable for any indirect, incidental, punitive, special or consequential damages (including, without limitation, lost profits, lost savings, business interruption, costs related to the removal or replacement of any products or rework charges) whether or not such damages are based on tort (including negligence), warranty, breach of contract or any other legal theory.

### Right to Make Changes

NVE reserves the right to make changes to information published in this document including, without limitation, specifications and product descriptions at any time and without notice. This document supersedes and replaces all information supplied prior to its publication.

### Use in Life-Critical or Safety-Critical Applications

Unless NVE and a customer explicitly agree otherwise in writing, NVE products are not designed, authorized or warranted to be suitable for use in life support, life-critical or safety-critical devices or equipment. NVE accepts no liability for inclusion or use of NVE products in such applications and such inclusion or use is at the customer's own risk. Should the customer use NVE products for such application whether authorized by NVE or not, the customer shall indemnify and hold NVE harmless against all claims and damages.

### Applications

Applications described in this datasheet are illustrative only. NVE makes no representation or warranty that such applications will be suitable for the specified use without further testing or modification.

Customers are responsible for the design and operation of their applications and products using NVE products, and NVE accepts no liability for any assistance with applications or customer product design. It is customer's sole responsibility to determine whether the NVE product is suitable and fit for the customer's applications and products planned, as well as for the planned application and use of customer's third party customers. Customers should provide appropriate design and operating safeguards to minimize the risks associated with their applications and products.

NVE does not accept any liability related to any default, damage, costs or problem which is based on any weakness or default in the customer's applications or products, or the application or use by customer's third party customers. The customer is responsible for all necessary testing for the customer's applications and products using NVE products in order to avoid a default of the applications and the products or of the application or use by customer's third party customers. NVE accepts no liability in this respect.

### Limiting Values

Stress above one or more limiting values (as defined in the Absolute Maximum Ratings System of IEC 60134) will cause permanent damage to the device. Limiting values are stress ratings only and operation of the device at these or any other conditions above those given in the recommended operating conditions of the datasheet is not warranted. Constant or repeated exposure to limiting values will permanently and irreversibly affect the quality and reliability of the device.

### Terms and Conditions of Sale

In case an individual agreement is concluded only the terms and conditions of the respective agreement shall apply. NVE hereby expressly objects to applying the customer's general terms and conditions with regard to the purchase of NVE products by customer.

### No Offer to Sell or License

Nothing in this document may be interpreted or construed as an offer to sell products that is open for acceptance or the grant, conveyance or implication of any license under any copyrights, patents or other industrial or intellectual property rights.

### Export Control

This document as well as the items described herein may be subject to export control regulations. Export might require a prior authorization from national authorities.

### Automotive Qualified Products

Unless the datasheet expressly states that a specific NVE product is automotive qualified, the product is not suitable for automotive use. It is neither qualified nor tested in accordance with automotive testing or application requirements. NVE accepts no liability for inclusion or use of non-automotive qualified products in automotive equipment or applications.

In the event that customer uses the product for design-in and use in automotive applications to automotive specifications and standards, customer (a) shall use the product without NVE's warranty of the product for such automotive applications, use and specifications, and (b) whenever customer uses the product for automotive applications beyond NVE's specifications such use shall be solely at customer's own risk, and (c) customer fully indemnifies NVE for any liability, damages or failed product claims resulting from customer design and use of the product for automotive applications beyond NVE's standard warranty and NVE's product specifications.



An ISO 9001 Certified Company

NVE Corporation  
11409 Valley View Road  
Eden Prairie, MN 55344-3617 USA  
Telephone: (952) 829-9217

[www.nve.com](http://www.nve.com)  
e-mail: [sensor-info@nve.com](mailto:sensor-info@nve.com)

©NVE Corporation  
All rights are reserved. Reproduction in whole or in part is prohibited without the prior written consent of the copyright owner.

SB-00-027

*rev. Nov. 2017*