

Magnets

NVE offers several popular permanent magnets for use with magnetic sensors. In addition to individual magnets, NVE offers evaluation kits containing assortments of magnets, magnetic sensors, and printed circuit boards for sensor system development.

The following magnets are available:



| NVE Part No. | Description | Dimensions | Typ. Field at Face | Evaluation Kits |
|--------------|-------------------------------------|------------------------------------|--------------------|-------------------------------------|
| 12030 | Ferrite Bar Magnet | 0.5" L x 0.125" W x 0.25" T | 1500 Oe | AG001-01, AG040, AG940, and others |
| 12031 | Ferrite Disk Magnet | 0.312" dia. x 0.125" thick | 900 Oe | AG001-01 |
| 12032 | Ferrite Bar Magnet | 1" L x 0.125" W x 0.39" T | 1800 Oe | AG910-07; AG911-07 |
| 12216 | Ferrite Disk Magnet | 6 mm dia. x 4 mm thick | 1100 Oe | AG920-07 |
| 12217 | Ferrite Disk Magnet | 3.5 mm dia. x 4 mm thick | 1700 Oe | AG920-07 |
| 12249 | Split-Pole Ferrite Disk | 12 mm dia. x 4 mm thick | 1000 Oe | None (suitable for AAT/ADT sensors) |
| 12426 | Alnico-5 Split-Pole Round Horseshoe | 0.44" dia. x 0.44" H (see fig.) | 1100 Oe | AAT- and ADT-Series angle sensors |

Use our [Web application calculators](http://www.nve.com/spec/calculators.php) (www.nve.com/spec/calculators.php) to estimate the magnet fields at various distances.

Disc Magnets (C5, Y25, or similar)

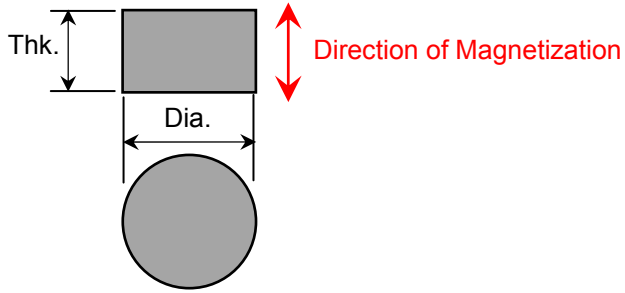

Bar Magnets (C1, Y10T, C5, Y25, or similar)

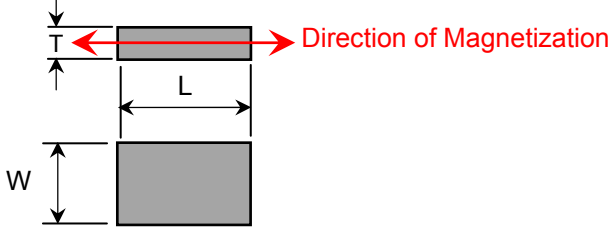

12249 Split-Pole Ferrite Disk Magnet (C5, Y25, or similar)

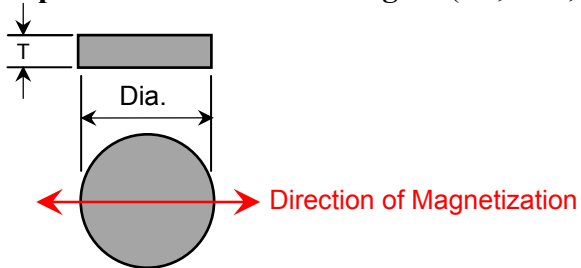

12426 Split-Pole Round Horseshoe Magnet (Alnico 5)

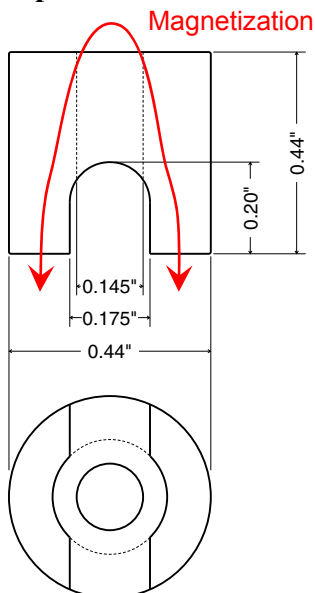

Magnet Material Specifications

| | C1/Y10T | C5/Y25 | Alnico-5 |
|---|----------------|---------------|-----------------|
| Maximum Operating Temperature | 300°C | 300°C | 525°C |
| Curie Temperature | 450°C | 450°C | 860°C |
| Temperature Coefficient of Flux Density | -0.20%/°C | -0.20%/°C | -0.02%/°C |
| Maximum Energy Product | 1 MGOe | 3.4 MGOe | 5.5 MGOe |
| Residual Induction | 2175 Gauss | 3800 Gauss | 12800 Gauss |
| Coercive Force | 1800 Oe | 2400 Oe | 640 Oe |

Material Characteristics

C1/Y10T Magnetic Characteristics

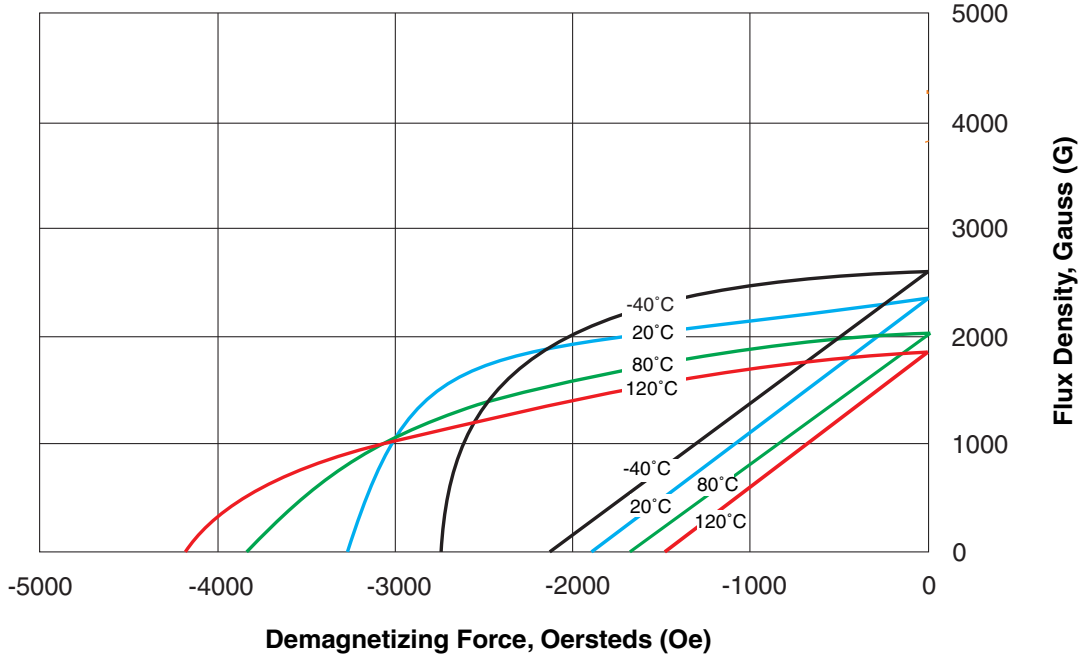

C5/Y25 Magnetic Characteristics

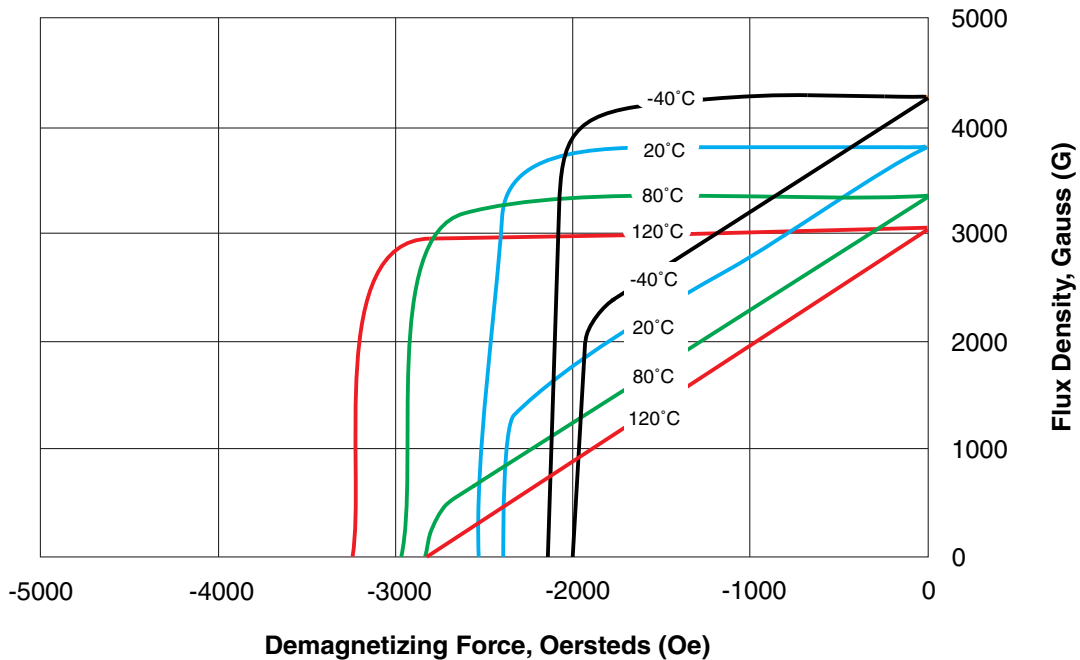

Alnico-5 Magnetic Characteristics

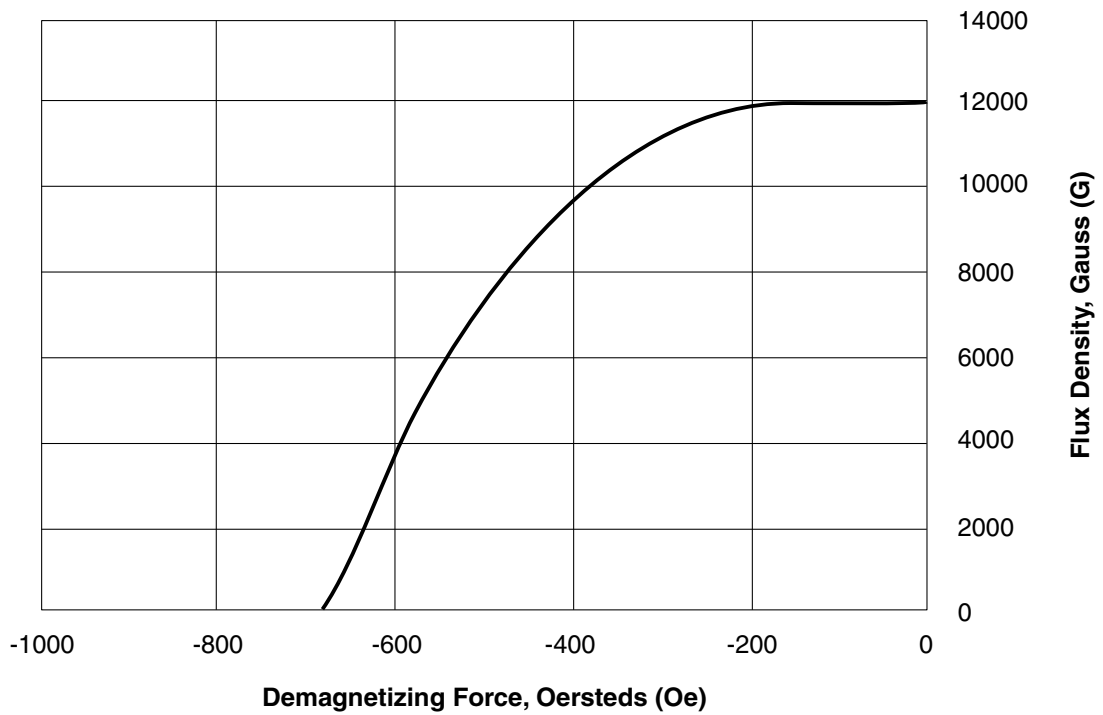

Datasheet Limitations

The information and data provided in datasheets shall define the specification of the product as agreed between NVE and its customer, unless NVE and customer have explicitly agreed otherwise in writing. All specifications are based on NVE test protocols. In no event however, shall an agreement be valid in which the NVE product is deemed to offer functions and qualities beyond those described in the datasheet.

Limited Warranty and Liability

Information in this document is believed to be accurate and reliable. However, NVE does not give any representations or warranties, expressed or implied, as to the accuracy or completeness of such information and shall have no liability for the consequences of use of such information.

In no event shall NVE be liable for any indirect, incidental, punitive, special or consequential damages (including, without limitation, lost profits, lost savings, business interruption, costs related to the removal or replacement of any products or rework charges) whether or not such damages are based on tort (including negligence), warranty, breach of contract or any other legal theory.

Right to Make Changes

NVE reserves the right to make changes to information published in this document including, without limitation, specifications and product descriptions at any time and without notice. This document supersedes and replaces all information supplied prior to its publication.

Use in Life-Critical or Safety-Critical Applications

Unless NVE and a customer explicitly agree otherwise in writing, NVE products are not designed, authorized or warranted to be suitable for use in life support, life-critical or safety-critical devices or equipment. NVE accepts no liability for inclusion or use of NVE products in such applications and such inclusion or use is at the customer's own risk. Should the customer use NVE products for such application whether authorized by NVE or not, the customer shall indemnify and hold NVE harmless against all claims and damages.

Applications

Applications described in this datasheet are illustrative only. NVE makes no representation or warranty that such applications will be suitable for the specified use without further testing or modification.

Customers are responsible for the design and operation of their applications and products using NVE products, and NVE accepts no liability for any assistance with applications or customer product design. It is customer's sole responsibility to determine whether the NVE product is suitable and fit for the customer's applications and products planned, as well as for the planned application and use of customer's third party customers. Customers should provide appropriate design and operating safeguards to minimize the risks associated with their applications and products.

NVE does not accept any liability related to any default, damage, costs or problem which is based on any weakness or default in the customer's applications or products, or the application or use by customer's third party customers. The customer is responsible for all necessary testing for the customer's applications and products using NVE products in order to avoid a default of the applications and the products or of the application or use by customer's third party customers. NVE accepts no liability in this respect.

Limiting Values

Stress above one or more limiting values (as defined in the Absolute Maximum Ratings System of IEC 60134) will cause permanent damage to the device. Limiting values are stress ratings only and operation of the device at these or any other conditions above those given in the recommended operating conditions of the datasheet is not warranted. Constant or repeated exposure to limiting values will permanently and irreversibly affect the quality and reliability of the device.

Terms and Conditions of Sale

In case an individual agreement is concluded only the terms and conditions of the respective agreement shall apply. NVE hereby expressly objects to applying the customer's general terms and conditions with regard to the purchase of NVE products by customer.

No Offer to Sell or License

Nothing in this document may be interpreted or construed as an offer to sell products that is open for acceptance or the grant, conveyance or implication of any license under any copyrights, patents or other industrial or intellectual property rights.

Export Control

This document as well as the items described herein may be subject to export control regulations. Export might require a prior authorization from national authorities.

Automotive Qualified Products

Unless the datasheet expressly states that a specific NVE product is automotive qualified, the product is not suitable for automotive use. It is neither qualified nor tested in accordance with automotive testing or application requirements. NVE accepts no liability for inclusion or use of non-automotive qualified products in automotive equipment or applications.

In the event that customer uses the product for design-in and use in automotive applications to automotive specifications and standards, customer (a) shall use the product without NVE's warranty of the product for such automotive applications, use and specifications, and (b) whenever customer uses the product for automotive applications beyond NVE's specifications such use shall be solely at customer's own risk, and (c) customer fully indemnifies NVE for any liability, damages or failed product claims resulting from customer design and use of the product for automotive applications beyond NVE's standard warranty and NVE's product specifications.

©NVE Corporation

All rights are reserved. Reproduction in whole or in part is prohibited without the prior written consent of the copyright owner.

SB-00-019

September 2017